

180-2755 Solder Terminal, Thru Hole

Recommended mounting hole .064 (1,63), #52 drill

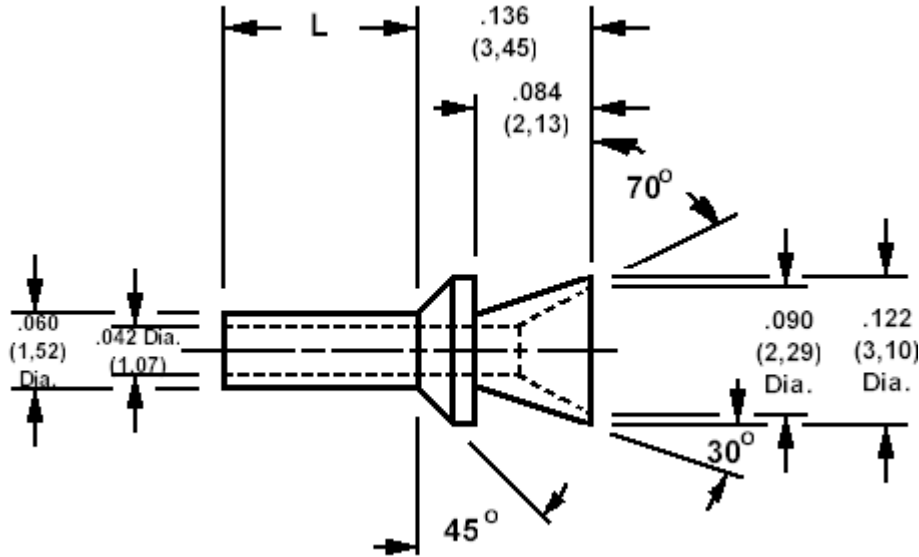

How to order code
180-2755-XX-YY-00

Basic Part No XX = L dimension, YY = Plating Finish

DIMENSIONS (XX)			
Basic Part No	(XX)	L	Board Thickness
180-2755	-01	.062 (1,57)	.031 (0,79)
	-02	.094 (2,39)	.062 (1,57)
	-03	.125 (3,18)	.094 (2,39)
	-04	.156 (3,96)	.125 (3,18)

MATERIALS		
Component	Material	Finish (YY)
		-05
Terminal	Brass	Electro Solder

SWAGE TOOLING	
Recommended Swaging Tools:-	
Anvil	435-6465-01-00-00
Flare Punch	435-6692-01-00-00